

# USER MANUAL

EV11k-AC-02



# CONTENT

<b>1 About this manual</b> .....	<b>01</b>
1.1 Copyright declaration .....	01
1.2 Structure of the manual .....	01
1.3 Scope .....	01
1.4 Target group .....	01
1.5 Symbols used .....	02
<b>2 Basic safety information</b> .....	<b>03</b>
2.1 Safety information .....	03
2.2 Qualified personnel .....	03
2.3 Installation requirements .....	04
2.4 Transport requirements .....	04
2.5 Label on the device .....	04
2.6 Operation .....	05
2.7 Repair and maintenance .....	06
2.8 Environmental protection .....	06
<b>3 System overview</b> .....	<b>07</b>
3.1 Buttons and display lights .....	07
3.2 EV11k-AC-02 introduction .....	08
3.3 Application Scenario .....	10
<b>4 Installation</b> .....	<b>11</b>
4.1 Installation information .....	11
4.2 Installation Tools .....	12
4.3 Device Installation .....	13
<b>5 System Electrical Topology</b> .....	<b>16</b>
5.1 Electrical connection .....	16
5.2 Connection with Inverter .....	17

**6 System commissioning operation.....18**

    6.1 Safety test before commissioning.....18

    6.2 Inverter configuration.....18

**7 Troubleshooting handling.....24**

    7.1 Trouble Light Signal .....24

    7.2 Maintenance .....25

**8 DataSheet .....26**

# 1 About this manual

## 1.1 Copyright declaration

The copyright of this manual is owned by SOFAR. It may not be copied neither partially nor completely by companies or individuals (including software, etc.) and must not be reproduced or distributed in any form, or with the appropriate means.

SOFAR reserves the right to final interpretation. This manual may be amended following feedback from users or customers. Please consult our website at <http://www.sofarsolar.com> for the latest version.

The current version was updated on 14/9/24.

## 1.2 Structure of the manual

This manual contains important safety and installation instructions that must be observed during installation and maintenance of the device.

## 1.3 Scope

This manual contains the application scenario, working mode, system wiring and device configuration of SOFAR 's Residential ESS + Wallbox system.

## 1.4 Target group

This manual is intended for specialist electrical engineers who are responsible for the installation and commissioning of the Wallbox in the PV system, as well as the PV system operators.

## 1.5 Symbols used

This manual contains information on safe operation and uses symbols to ensure the safety of persons and property as well as the efficient operation of the device. Please read through the following symbol explanations carefully in order to prevent injury or property damage.

### DANGER

**Non-observance will result in death or serious injury.**

- Follow the warnings in order to prevent death or serious injury!

### WARNING

**Non-observance may result in death or serious injury.**

- Follow the warnings in order to prevent serious injury!

### CAUTION

**Non-observance may result in minor injury.**

- Follow the warnings in order to prevent injury!

### ATTENTION

**Non-observance may result in property damage.**

- Follow the warnings in order to prevent damage to or destruction of the product.

### NOTE

- Provides tips essential to the optimal operation of the product.

# 2 Basic safety information

## NOTE

- If you have any questions or problems after reading the following information, please contact SOFAR.

This chapter details the safety information pertaining to the installation and operation of the device.

## 2.1 Safety information

Read and understand the instructions within this manual and familiarize yourself with the relevant safety symbols in this chapter before beginning with the installation of the device and eliminating any faults.

Before connecting to the power grid, you must obtain official authorization from the local power grid operator in accordance with the corresponding national and state requirements. Furthermore, operation may only be carried out by qualified electricians.

Please contact the nearest authorized service centre if any maintenance or repairs are required. Please contact your dealer to obtain information about your nearest authorized service centre. Do NOT carry out repairs on the device yourself; this may lead to injury or property damage.

Before installing the device or carrying out maintenance on it, you must open the DC switch in order to interrupt the DC voltage of the PV generator. You can also switch off the DC voltage by opening the DC switch in the generation junction box. Not doing this may result in serious injury.

## 2.2 Qualified personnel

Personnel tasked with the operation and maintenance of the device must have the qualifications, competence and experience required to perform the described tasks, while also being capable of fully understanding all instructions contained within the manual. For safety reasons, this Wallbox may only be installed by a qualified electrician who:

- has received training on occupational safety, as well as the installation and commissioning of electrical systems
- is familiar with the local laws, standards and regulations of the grid operator.

SOFAR assumes no responsibility for the destruction of property or any injuries to personnel caused by improper usage.

## 2.3 Installation requirements

 **DANGER**

- Please strictly observe all warnings on the device and user manuals. The cover of the charge point is only to be removed by a qualified electrician.

 **DANGER**

**Installation circumstance**

- Please consider charge point protection against lightning and heavy rain.

 **DANGER**

**Keep away from children**

- Keep children away from the charge point.

Please install the product according to the information contained in the following section. Mount the product to a suitable object with a sufficient load-bearing capacity (e.g. walls, PV frames etc.) and ensure that the product is upright. Choose a suitable place for the installation of electrical devices. Ensure that there is sufficient space for an emergency exit which is suitable for maintenance. Ensure sufficient ventilation in order to guarantee an air circulation for the cooling of the product.

## 2.4 Transport requirements

The factory packaging is specifically designed to prevent transport damage, i.e. violent shocks, moisture and vibrations. However, the device must not be installed if it is visibly damaged. In this case, notify the responsible transport company immediately.

## 2.5 Label on the device

The labels must NOT be concealed by items and foreign objects (rags, boxes, devices, etc.); they must be regularly cleaned and kept clearly visible at all times.

 **DANGER****Dangerous DC voltage**

- Before establishing the electrical connection, cover the PV modules using opaque material or disconnect the PV generator from the inverter. Solar radiation will cause dangerous voltage to be generated by the PV generator!

 **NOTE**

- Do not open the Wallbox or remove any of the labels. Otherwise, SOFAR shall assume no guarantee.

## 2.6 Operation

 **DANGER****Electric shock**

- Do not use the Wallbox to charge the car while it is starting.
- Contact with the electrical grid or the device's terminals may result in an electric shock or fire!
- Do not touch the terminal or the conductor which is connected to the electrical grid.
- Follow all instructions and observe all safety documents that refer to the grid connection.

 **CAUTION****Burning due to hot housing**

- While the Wallbox is being operated, several internal components will become very hot.
- Please wear protective gloves!
- Keep children away from the device!



## 2.7 Repair and maintenance

### DANGER

#### Dangerous voltage

- Before carrying out any repair work, first switch off the AC circuit breaker between the Wallbox and power grid, and then the DC switch.
- After switching off the AC circuit breaker and the DC switch, wait a minimum of 5 minutes before starting any maintenance or repair work.

### DANGER

#### Moisture risk

- Keep the charge point socket clean and dry. If it gets dirty, please wipe it with a clean, dry cloth.

### ATTENTION

#### Unauthorized repairs!

- Following the elimination of any faults, the product should be fully functional once more. Should any repairs be required, please contact a local authorized service centre.
- The internal components of the product must NOT be opened without the relevant authorization. Shenzhen SOFARSOLAR Co., Ltd. assumes no responsibility for any resulting losses or defects.

## 2.8 Environmental protection

### NOTE

- Our packaging materials are environmentally friendly and can be recycled. Please put the packaging in applicable containers to recycle it. Do not dispose of this device with the household waste. It should be taken to a suitable facility for recycling of electrical and electronic devices. For more detailed information about recycling of this device, please contact your local city/town council office or your household waste disposal service.

# 3 System overview

This chapter describes the product features, application scenario and working mode.

## 3.1 Buttons and display lights

### 3.1.1 System introduction

SOFAR Residential ESS + Wallbox adds Wallbox system based on the residential storage system, which supports charging with PV power and multiple modes for energy management.

The solution includes energy storage inverter, battery, Wallbox, WiFi stick, smart meters, SOFAR cloud monitoring and other products.

#### Products List

Product	model name	function
Inverter	HYD 5-20KTL-3PH	Converts PV power to AC output for vehicle charging and load use
Battery	BTS E5-20-DS5	Storing excess PV energy to optimise energy scheduling
Wallbox	EV11k-AC-02	Muti-mode management of vehicle charging
Smart meter	DTSU666	Measure the power of point of common coupling, communicate with inverter
WiFi Stick	LSW-3	Cloud communication for inverters
APP	SOFAR Cloud	System remote status monitoring and control

## 3.2 EV11k-AC-02 introduction

### 3.2.1 External structure

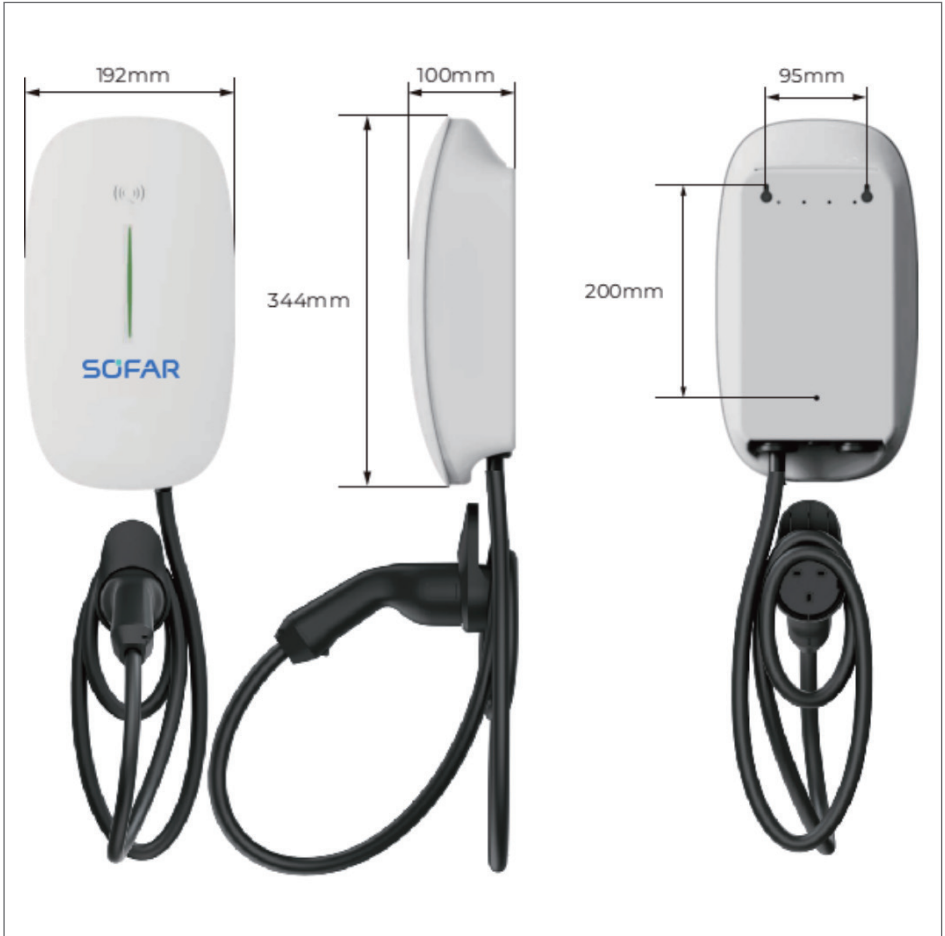

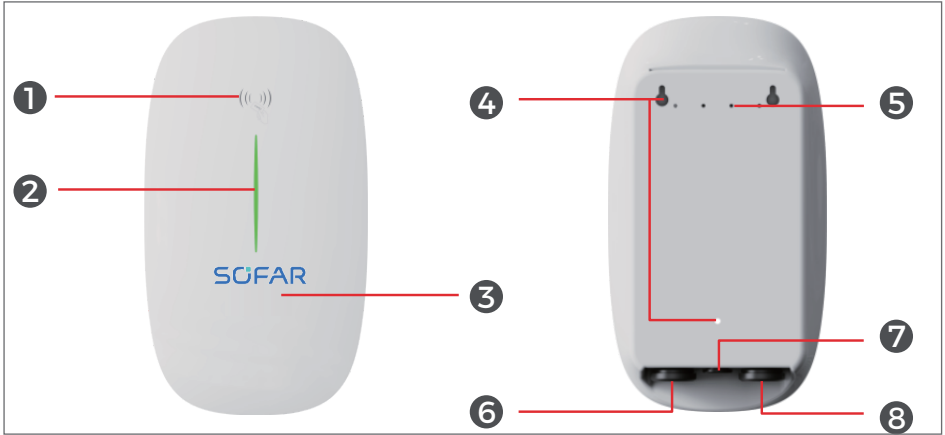

①	RFID Card Reader The RFID card can be read in this area.	⑤	Drain Holes Prevent water penetration from the top.
②	Indicator Strip Green light Yellow light Red light.	⑥	Charging Cable Hole For charging connector.
③	Logo Only.	⑦	Reserved Hole for network cable.
④	Mounting Holes To fix the charger on the wall after inserting screws.	⑧	Incoming Cable Hole for incoming cable.

### 3.2.2 Other introduction

Refer to the Wallbox owner's manual for products on other information.

### 3.3 Application Scenario

#### 3.3.1 Residential ESS + Wallbox Scenarios

Wallbox residential storage inverter and storage battery are combined. Utilizing surplus photovoltaic energy to charge vehicle. Inverter carries out energy scheduling according to the actual load need and realize that the surplus PV energy is used to charge the vehicle.

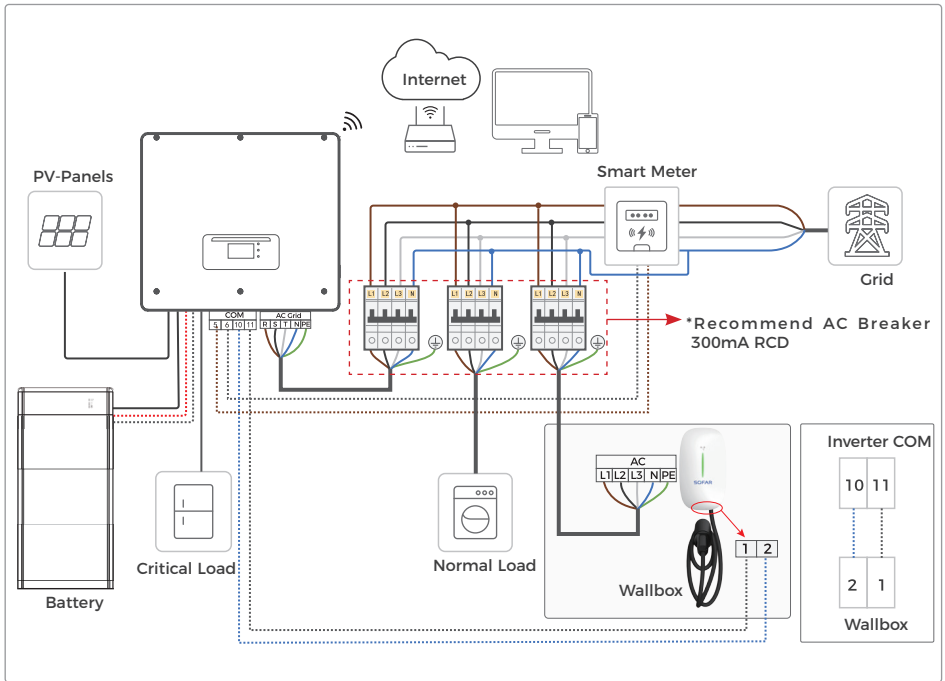

# 4 Installation

## 4.1 Installation information

### DANGER

#### Fire hazard

- Do NOT install the Wallbox on flammable material.
- Do NOT install the Wallbox in an area in which flammable or explosive material is stored.

### DANGER

#### Risk of electric shock

- All installations and electrical connections may only be carried out by trained electricians!

### CAUTION

#### Burning hazard







- Do NOT install the Wallbox in places where it can be accidentally touched. The housing and heat sink may become very hot while the Wallbox is being operated!

### ATTENTION

#### Non-observance may result in property damage!

- Choose a suitable installation location and surface.
- Commission a minimum of two persons for the installation of the Wallbox.

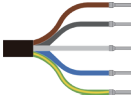
## 4.2 Installation Tools

No.	Picture	Name
1		Marking Pen
2		Hammer
3		Electric Drill (Φ6mm)
4		Cross Screwdriver
5		Wire Stripper
6		Five-core Outdoor Copper Cable (14 AWG)
7		Two-core Outdoor Shielded Twisted Pair cable(18~28 AWG)

### 4.3 Device Installation

1. Based on the installation position template, identify the installation position and mark the two holes for the wall screws, which will be inserted in the top rear of the charger.
2. Drill two holes with the 6mm diameter drill bit and insert the plugs horizontally into the holes, paying attention to the force and depth with which they are inserted (make sure the plug completely enters the hole).
3. Insert the two M4x32 screws into the wall plugs, allowing the heads of the screws to protrude by at least 5mm.
4. Provisionally position the charger by inserting the head of the screws into the upper holes at the rear.
5. Open the front of the charger.
6. Mark the position of the third fastening screw. The hole is located at the bottom of the charger.
7. Remove the station and make the third hole, inserting the wall plug.
8. Reposition the station and secure the third screw at the bottom.

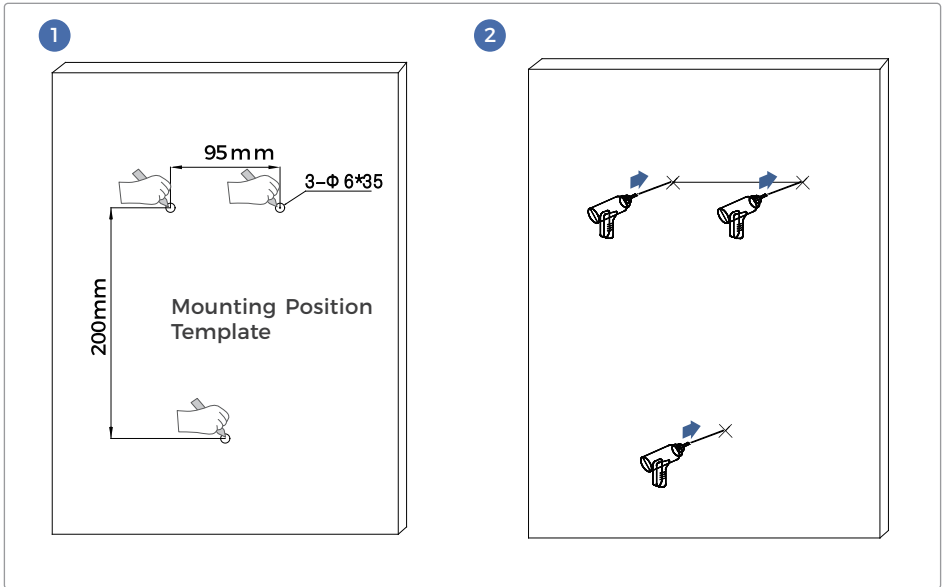



3

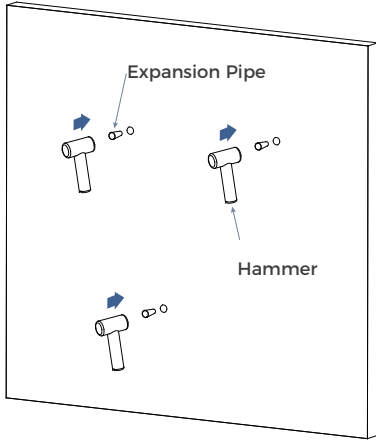

4

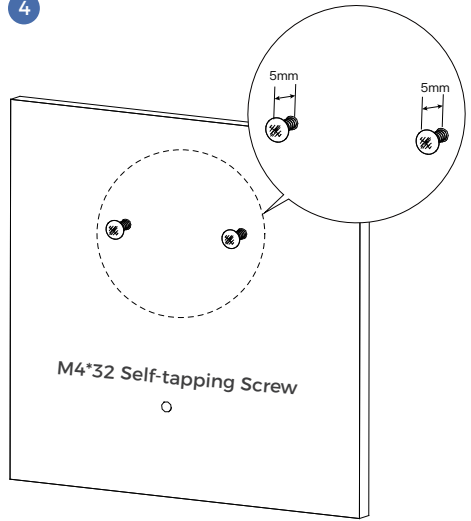

5

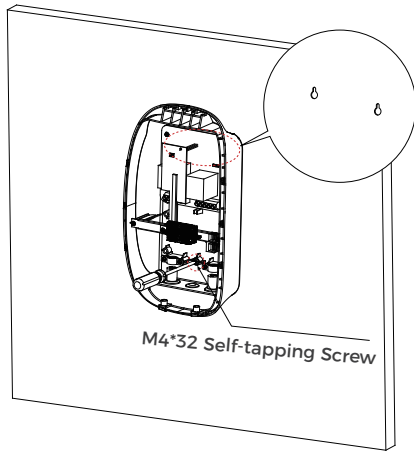

6

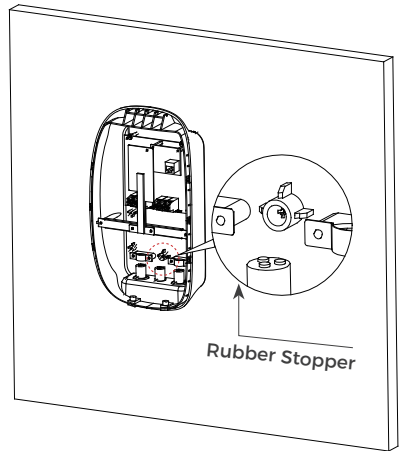

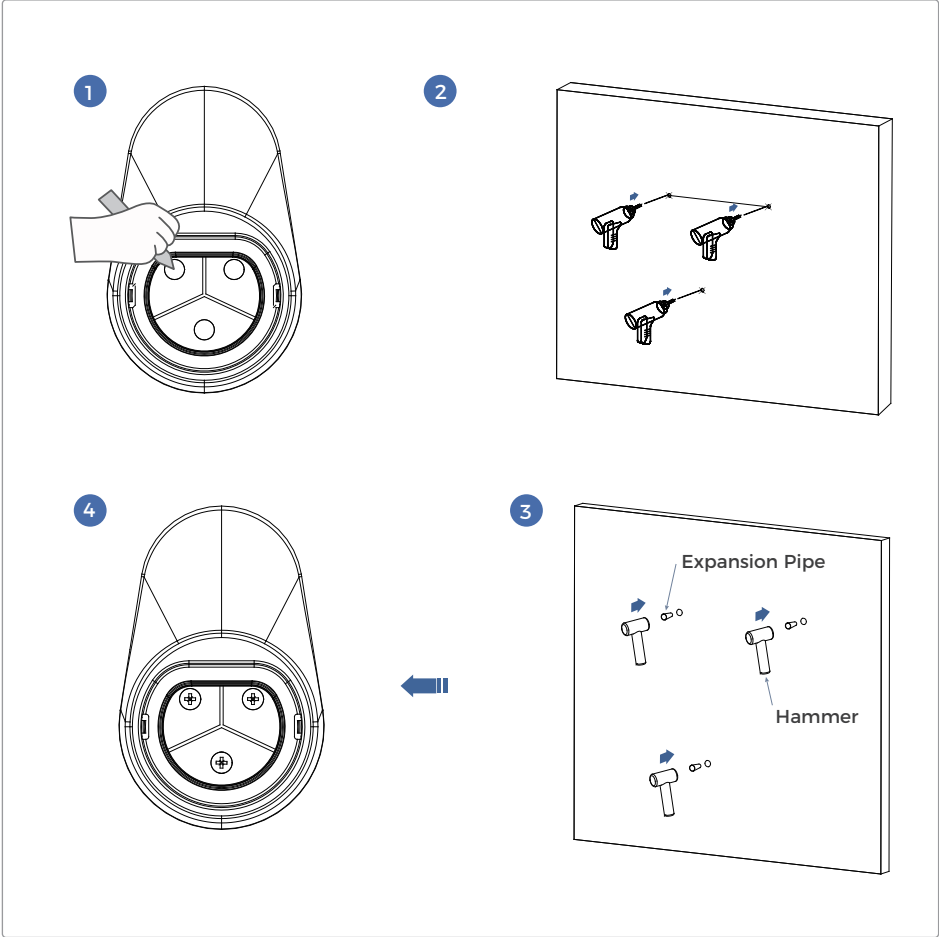

# 5 System Electrical Topology

## ⚠ NOTE

- This document only gives the system wiring schematic, and does not cover specific port definitions and wiring operation guidelines. For details, refer to the user manual of each device.

## 5.1 Electrical connection

Before insert input power wire, please cut silicon sealed loop as required to maintain IP65.

1. Remove a length of 40mm of the cable jacket and strip the wire insulation to a length of 8~15mm.
2. Crimp the terminals as shown in the figure below.
3. Insert the wire into the corresponding wire slot.

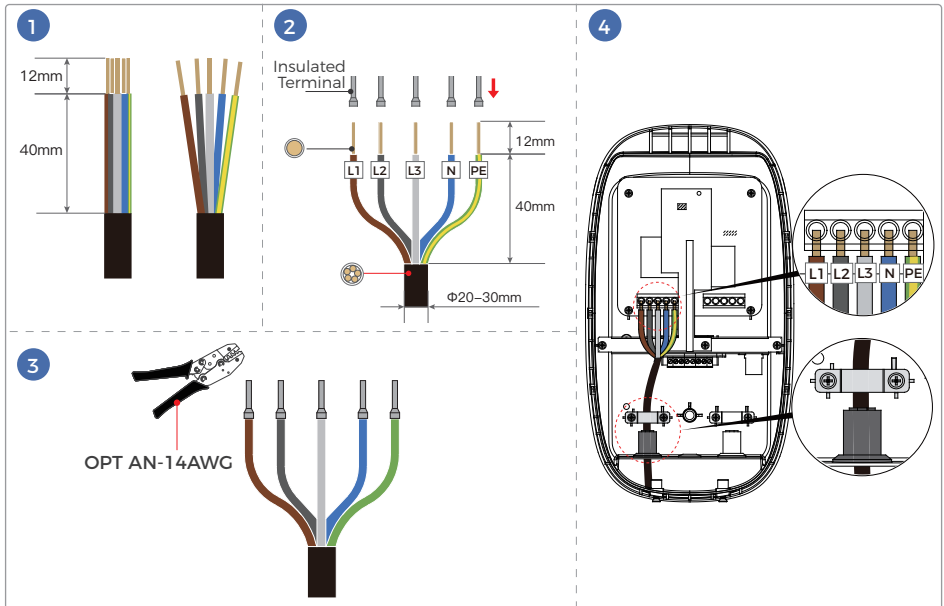

## 5.2 Connection with Inverter

RS485 communication protocol to obtain the information of Wallbox. Energy distribution and scheduling of the residential ESS + Wallbox system is carried out by the inverter.

Take the three-phase residential power conversion system HYD 5-20KTL-3PH. First, open the top cover of the 'Wallbox' according to step 4.3. Then, inside the Wallbox locate the 6-pin communication terminal in the center.

Connect the first hole on the left side of the terminal to Pin11 on the COM side of the inverter, and connect the second hole on the right side of the terminal to Pin10 on the COM side of the inverter.

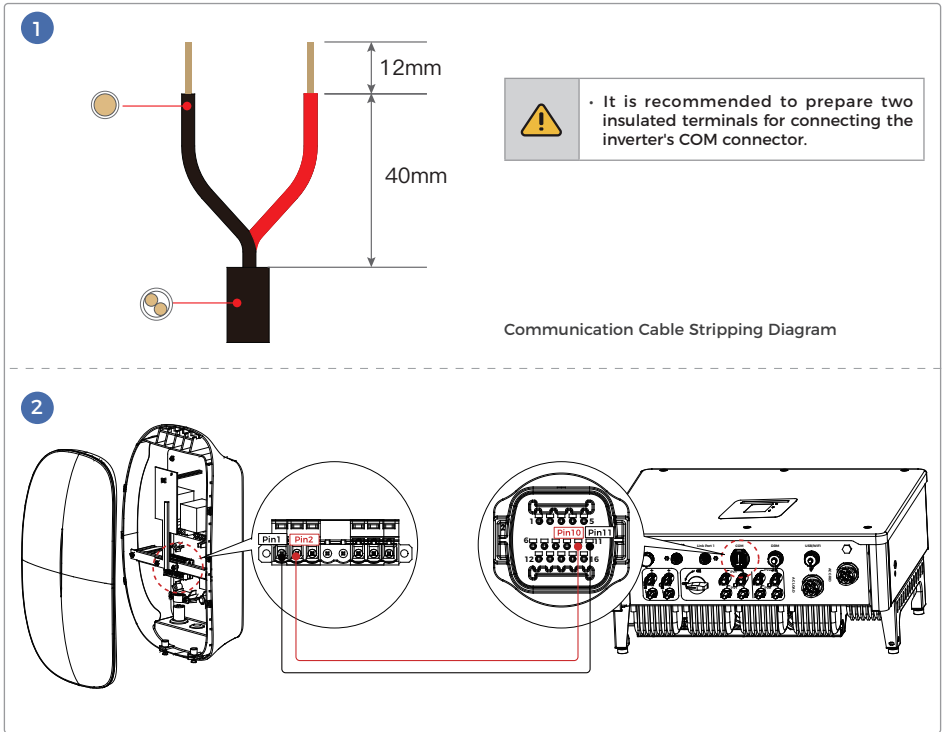

# 6 System commissioning operation

## 6.1 Safety test before commissioning

**ATTENTION**

**Check the voltage range**

- Ensure that the AC voltages are within the permissible range of the Wallbox.

## 6.2 Inverter configuration

There are a few settings that need to be made on the inverter before using Wallbox.

Press the button to bring up the main menu and set it up as follows.

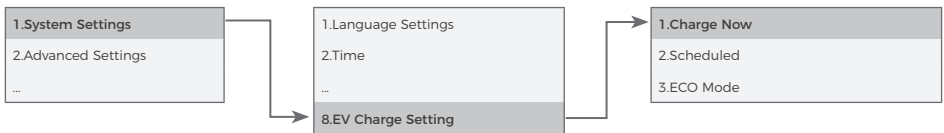

### 1.EV Charger Settings

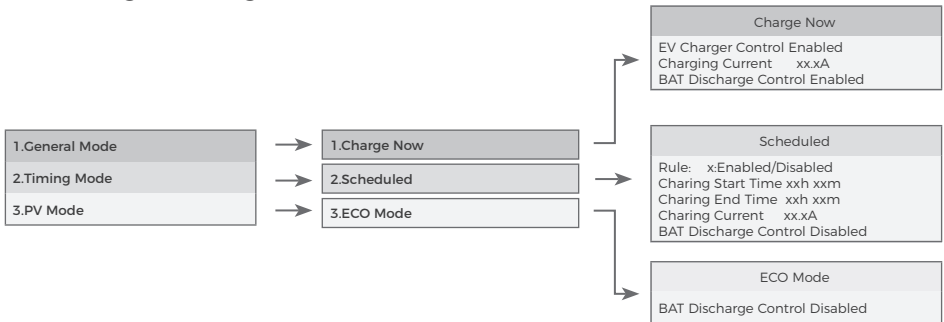

Three charging modes:

**Charge Now:**The power setting and start-stop control of the charging pile are realized on the inverter LCD screen and APP. The charging process requires statistics and reality of the charging voltage, current, power, charging time and accumulated charging amount, and can detect the start-stop control of the swipe card and end the charging in time.

**Scheduled:**The charging pile power and timing start-stop control Settings (maximum 4 rules are supported) are realized on the inverter LCD screen and APP. The charging process requires statistics and reality of the charging voltage, current, power, charging time and accumulated charging amount, and can detect the start-stop control of the swipe card and end the charging in time.

**ECO Mode:**the low-power single-phase 6A/1.4kW mode is started, and the AC charging pile power is adjusted according to the photovoltaic power. The single-phase maximum support is 16A/4.2kW. When the power is 4.2kW, the single-phase is switched to the three-phase 6A/4.2kW mode, and the current/ power is adjusted in the three-phase mode (the current of each phase is not less than 6A, not more than 16A), and the photovoltaic utilization rate is improved. Pay attention to the corresponding time limit of the charging pile and the vehicle charger, and adjust the current limit of the charging pile no more than 30s/ time (it is recommended that the power command write interval of 1min).

## 2.Disable the Feed-in limit function

When the Feed-in limit function is enabled, the residential storage system will prohibit the delivery of energy to the grid. If using the Wallbox, the Feed-in limit settings should be Disable.

Press  the button to bring up the main menu and set it up as follows.

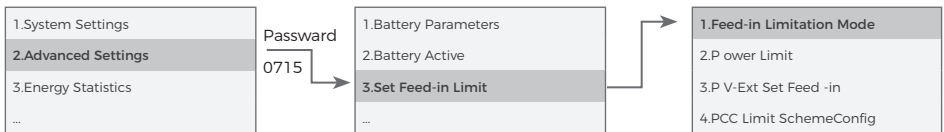

Then set the “Feed-in Limitation Mode” function to disabled.

### NOTE

- For more information, please refer to the user manual of HYD 5-20KTL-3PH.

### 3.PCC Purchase Control

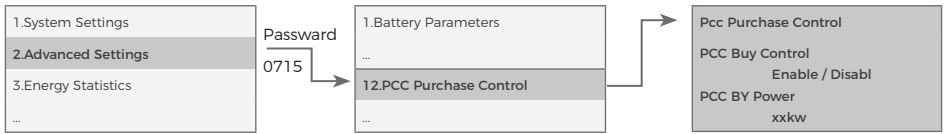

This option limits the maximum power value that can be taken from the grid. If you enable this option, please note :

- The PCC Buy power you set must be greater than the maximum power of Wallbox + needed load power

### 6.2.1 Plug & Charge

#### 1.Standby

A green indicator flashing slowly for 1s at 3s intervals indicates the charger is ready to use.

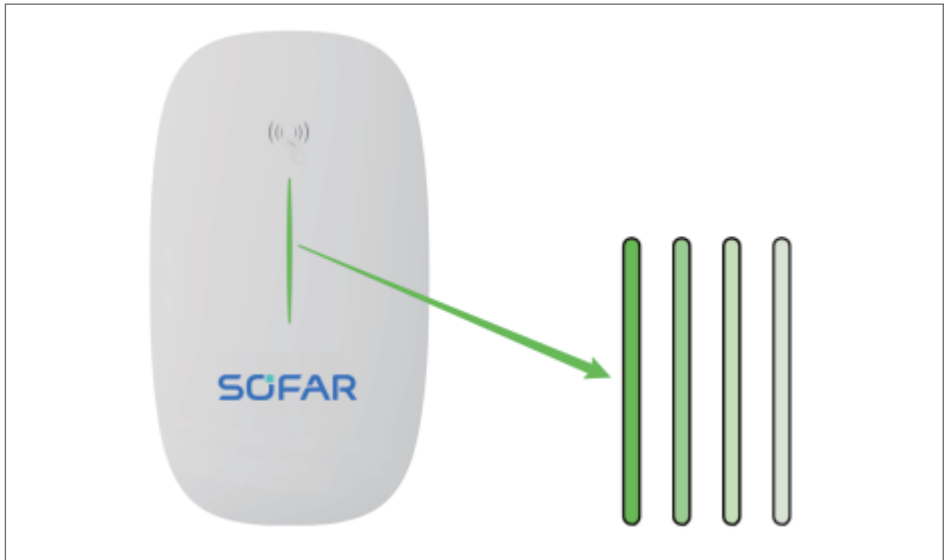

### 2.Plug in

Plug the charging connector into your EV's charging socket. A green indicator flashing for 200ms at 1-sec intervals indicates the charging connector is plugged in.



### 3.Charging

A green indicator breathing at 1sec intervals indicates the charging is in progress.

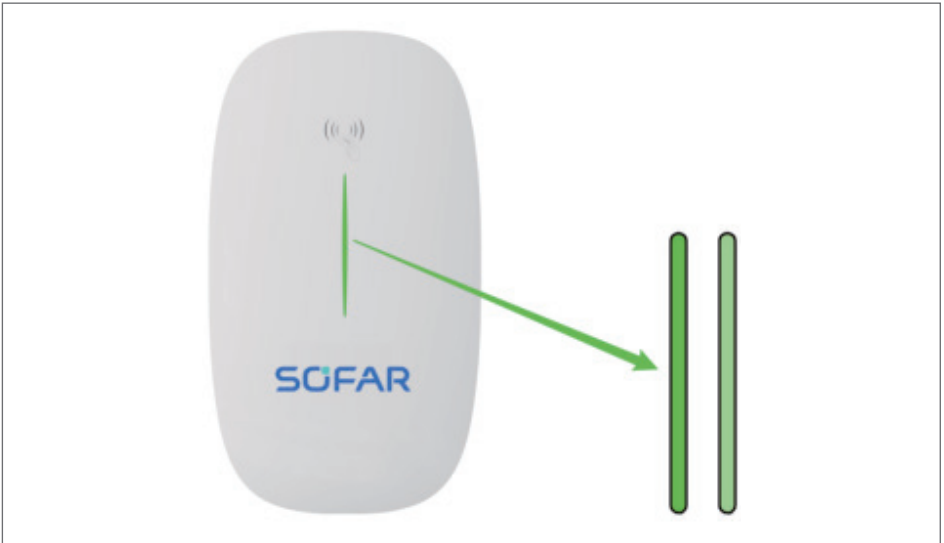



#### 4. Fully charged

Solid green light indicates the EV is fully charged.

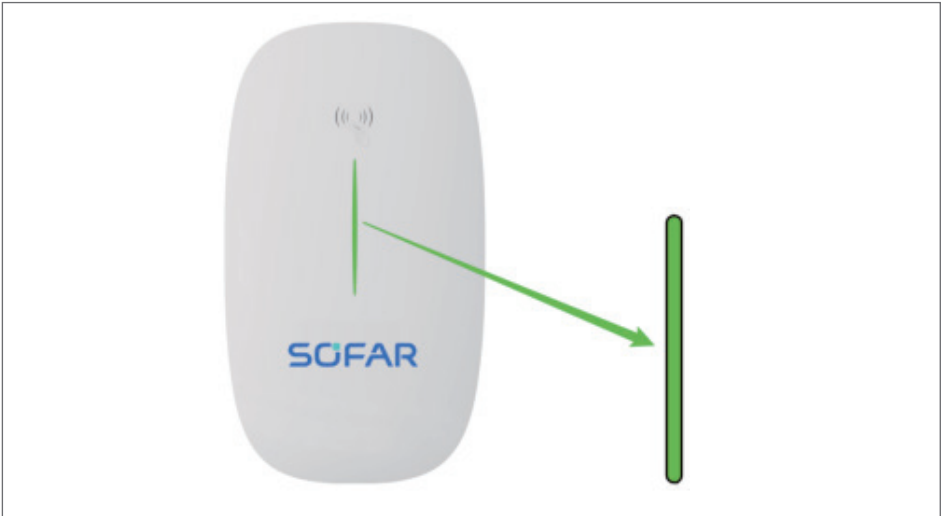

#### 5. Unplug

Unplug the charging connector. Return to standby mode after the charging has finished.



## 6.2.2 Use RFID Card

### 1.Plug in

Plug the charging connector into your EV's charging socket. A green indicator flashing for 200ms at 1-sec intervals indicates the charging connector is plugged in.



### 2.Use RFID Card

Put the RFID card on the reading area to start or stop charging. A yellow indicator flashing at 100-ms intervals indicates the RFID card is successfully read.

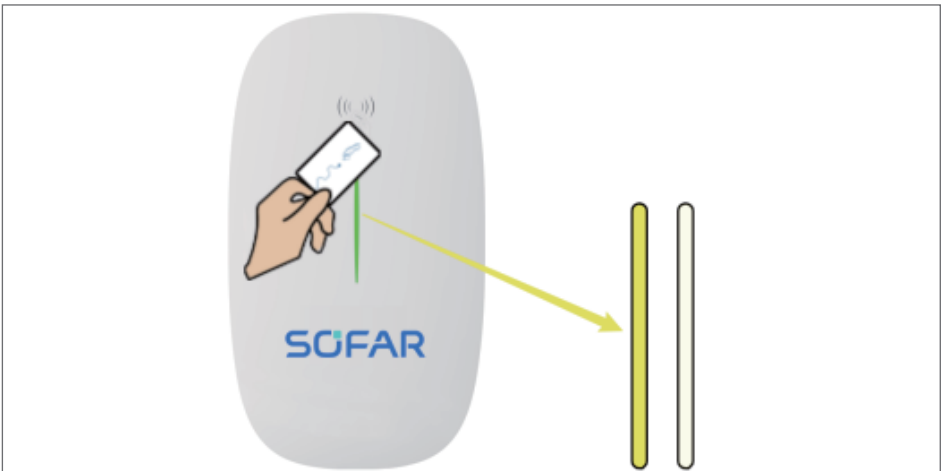

# 7 Troubleshooting handling

## 7.1 Trouble Light Signal

Problems	Light Status
Warning	Solid yellow light
Relay adhesion	Solid red light
Leakage current fault	Flashing red, 500ms on, 500ms off, 1 time, 3S off, Cycle
CP fault	Flashing red, 500ms on, 500ms off, 2 times, 3S off, Cycle
Over current fault	Flashing red, 500ms on, 500ms off, 3 times, 3S off, Cycle
Input polarity reverse	Flashing red, 500ms on, 500ms off, 4 times, 3S off, Cycle
Leakage current loop abnormal	Flashing red, 500ms on, 500ms off, 5 times, 3S off, Cycle
Input terminal overtemperature	Flashing red, 500ms on, 500ms off, 6 times, 3S off, Cycle
Relay overtemperature	Flashing red, 500ms on, 500ms off, 7 times, 3S off, Cycle
Over/Under voltage fault	Solid yellow light blocks for 2S and flashing red, 500ms on, 500ms off, 1 time, 3S off, Cycle
Over/Under frequency fault	Solid yellow light blocks for 2S and flashing red, 500ms on, 500ms off, 2 times, 3S off, Cycle
Meter comm abnormal	Solid yellow light blocks for 2S and flashing red, 500ms on, 500ms off, 3 times, 3S off, Cycle
Smart meter comm abnormal	Solid yellow light blocks for 2S and flashing red, 500ms on, 500ms off, 4 times, 3S off, Cycle
CT fault	Solid yellow light blocks for 2S and flashing red, 500ms on, 500ms off, 5 times, 3S off, Cycle
Charging connector lock abnormal	Solid yellow light blocks for 2S and flashing red, 500ms on, 500ms off, 6 times, 3S off, Cycle
Charging connector current abnormal	Solid yellow light blocks for 2S and flashing red, 500ms on, 500ms off, 7 times, 3S off, Cycle

## 7.2 Maintenance

No.	Item	Operating process
1	Keep the Wallbox clean	Use a cloth to clean the charger surface. If there is any damage or dirt on the vehicle connector, charging cable, or vehicle connector holder, please contact customer service immediately
2	Keep the Wallbox intact	Do not hit or press hard on the case. If the case is damaged, please contact customer service
3	Avoid letting moisture or water enter the Wallbox	If there is water or moisture inside the charging station, you must immediately switch off the electricity supply to avoid immediate danger. Please notify your maintenance professional before continuing to use the station.
4	Avoid Wallbox rusted	Keep the charging station away from dangerous substances such as flammable gases and corrosive materials

# 8 DataSheet

Model	EV11k-AC-02
<b>AC Input &amp; Output</b>	
Nominal Charging Power	11 kW
Nominal Output Voltage	3P/N/PE 220-240/380-415 Va.c
Max. output current	16 A
Nominal AC Frequency	50/60 Hz
Vehicle Connection	Type 2 Cable
Charging Cable Length	7 m
<b>User Interface &amp; Communication</b>	
Protocol	OCPP 1.6 JSON
Communication	RS485 / Wi-Fi / BLE, Optional: Ethernet / 4G
Display	LED indicator / APP
Metering	Integrated metering IC
<b>Protection</b>	
Residual Current Protection	TypeA+6mA DC detection
Over / Under Voltage Protection	Supported
Overload Protection	Supported
Over / Under Frequency Protection	Supported
Over Temperature Protection	Supported
Surge Protection	Supported
Grounding System	TT / TN

<b>General Data</b>	
Dimensions(H / W / D)	344*192*100mm
Weight	4.2kg
Operating Temperature Range	-30~+50°C
Ambient Humidity	5%~95%
Working Altitude	<2000m
Cooling Mode	Natural
Ingress Protection	IP65
Installation method	Wall-mounted
<b>Standard Compliance</b>	
Standard	EN IEC 61851-1, IEC62955, IEC 61851-21-2, EN IEC 61000-6-1, EN 61000-6-3, EN 300 328 V2.2.2, EN 300 330 V2.1.1, EN 62311, EN 301 489-1 V2.2.3, EN 301 489-3 V2.1.1, EN 301 489-17 V3.2.0



ENERGY TO POWER YOUR LIFE

**ADDRESS**

11th Floor, Gaoxingqi Technology Building,  
District 67, Xingdong Community, Xin'an Street,  
Bao'an District, Shenzhen, China

**EMAIL**

[info@sofarsolar.com](mailto:info@sofarsolar.com)

**WEBSITE**

[www.sofarsolar.com](http://www.sofarsolar.com)

SOFARSOLAR 

